

MARK	DESCRIPTION	SNAG	DATE

2 3 4 5 6 7 8 9 10 11 12

A B C D E F G H

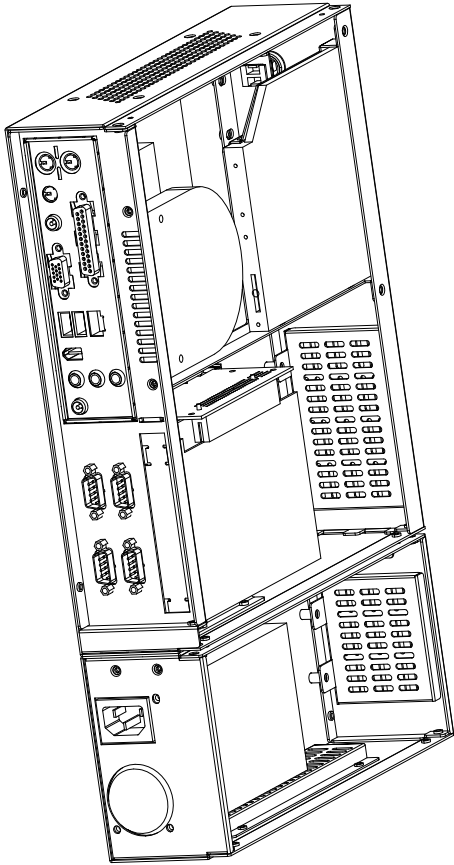
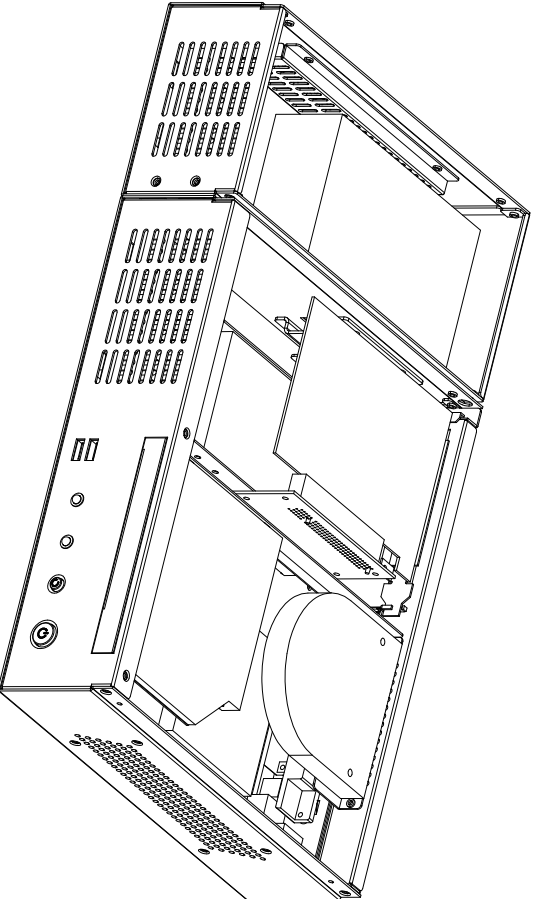
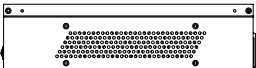
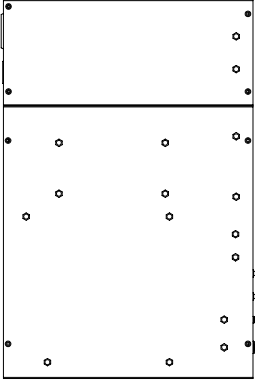
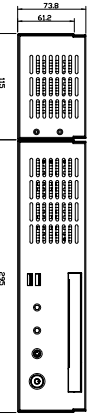
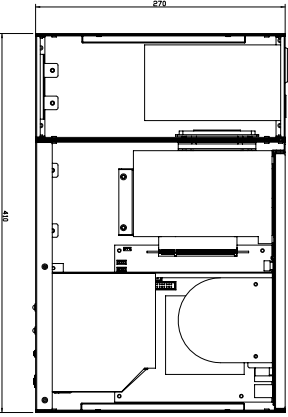
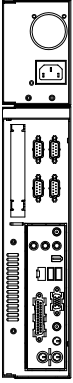
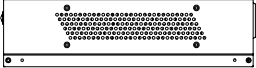

NOTE:
 1. THE FRONT PANEL IS FILED IN 0.01mm
 2. DIMENSIONS ARE IN MILLIMETERS
 3. DIMENSIONS ARE IN MILLIMETERS

TEL	NO	DATE	REV	BY	CHKD	APP'D

NAME	DESIGN	DATE	REV	BY	CHKD	APP'D

A B C D E F G H