

# LS-371

---

3.5 inch Miniboard

User's Manual

Edition 1.0

2006/11/29



## **Copyright**

Copyright 2006. All rights reserved. This document is copyrighted and all rights are reserved. The information in this document is subject to change without prior notice to make improvements to the products.

This document contains proprietary information and protected by copyright. No part of this document may be reproduced, copied, or translated in any form or any means without prior written permission of the manufacturer.

All trademarks and/or registered trademarks contains in this document are property of their respective owners.

## **Disclaimer**

The company shall not be liable for any incidental or consequential damages resulting from the performance or use of this product.

The company does not issue a warranty of any kind, express or implied, including without limitation implied warranties of merchantability or fitness for a particular purpose.

The company has the right to revise the manual or include changes in the specifications of the product described within it at any time without notice and without obligation to notify any person of such revision or changes.

## **Trademark**

All trademarks are the property of their respective holders.

---

# Packing List

Please check the package before you starting setup the system

## Hardware:

LS-371 miniboard x 1

## Cable Kit:

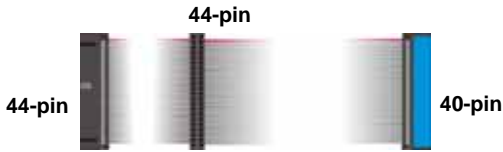

ATA33 IDE Cable x1



DC Power Cable x 1



SATA Power Cable x 1



SATA Cable x 2



PS/2 keyboard & mouse cable x 1



1 to 3 power output cable

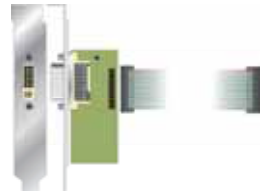

DVI module with bracket x 1

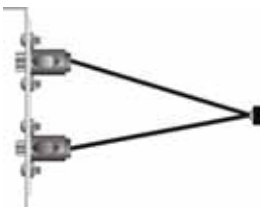

SDTV Cable x 1

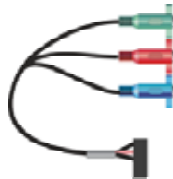

YPbPr Cable x 1



Audio Port Cable x 1



**CPU Cooler x 1**



**USB Cable x 1**



**COM Port Cable x 1**

**Printed Matters:**

**User's Manual x 1**

**Driver CD x 1**

## Index

<b>Chapter 1 &lt;Introduction&gt;</b> .....	<b>8</b>
1.1 <Product Overview> .....	8
1.2 <Product Specification> .....	9
1.3 <Mechanical Drawing> .....	11
1.4 <Block Diagram> .....	12
<b>Chapter 2 &lt;Hardware Setup&gt;</b> .....	<b>13</b>
2.1 <Connector Location> .....	13
2.2 <Jumper Reference> .....	15
2.3 <Connector Reference> .....	16
2.3.1 <Internal Connector> .....	16
2.3.2 <External Connector> .....	16
2.4 <CPU and Memory Setup> .....	17
2.4.1 < CPU> .....	17
2.4.2 <Memory> .....	18
2.5 <CMOS ATX Setup> .....	19
2.6 <Enhanced IDE & CF Interface> .....	20
2.7 <Serial ATA Interface> .....	21
2.8 <LAN Interface> .....	21
2.9 <Onboard Display Interface> .....	22
2.9.1 <Analog VGA Interface> .....	22
2.9.2 <Digital Display> .....	23
2.9.3 <DVI Interface > .....	26
2.9.4 <TV-out Interface> .....	27
2.10 <Onboard Audio Interface> .....	30
2.11 <USB2.0 Interface> .....	31
2.12 <GPIO Interface> .....	33
2.13 <Serial Port Jumper Setting > .....	34
2.14 <Power and Fan Connector > .....	36

2.14.1 <Power Input> .....	36
2.14.2 <Power Output> .....	37
2.14.3 <Fan Connector>.....	37
2.15 <Indicator and Switch>.....	37
<b>Chapter 3 &lt;System Configuration&gt;.....</b>	<b>40</b>
3.1 <Video Memory Setup> .....	40
3.2 <AudioConfiguration> .....	42
<b>Chapter 4 &lt;BIOS Setup&gt;.....</b>	<b>44</b>
<b>Appendix A &lt;I/O Port Pin Assignment&gt;.....</b>	<b>46</b>
A.1 <IDE Port> .....	46
A.2 <IrDA Port> .....	47
A.3 < CRT Port >.....	47
A.4 <Serial ATA Port> .....	47
A.5 <Serial Port> .....	48
A.6 <LAN Port> .....	48
<b>Appendix B &lt;Flash BIOS&gt;.....</b>	<b>49</b>
B.1BIOS Auto Flash Tool .....	49
B.2Flash Method .....	49
<b>Appendix C &lt;System Resources&gt; .....</b>	<b>50</b>
<b>Appendix D &lt;Watch Dog timer Setting &gt;.....</b>	<b>54</b>
<b>Contact Information .....</b>	<b>56</b>

**(The Page is Left For Blank)**

## **Chapter 1 <Introduction>**

### **1.1 <Product Overview>**

**LS-371** is the 3.5 inch miniboard, with supporting Intel Core 2 Dual/Core Dual/ Core Solo processors for 533/667MHz front side bus, Intel 945GM and ICH7-M chipset, integrated GMA950 graphics, DDR2 SO-DIMM memory, Realtek AC97 Audio, Serial ATA and one Intel 82573L Gigabit LAN .

#### **Intel Yonah dual core Processor**

The board supports Intel Core 2 Dual/Core Dual/Core Solo processor with 533/667MHz front side bus, 2MB L2 cache, to provide more powerful performance than before.

#### **New features for Intel 945GM chipset**

The board integrates Intel 945GM and ICH7-M chipset, to provide new generation of the mobile solution, supports Intel GMA950 graphics, DDR2 533/667 memory, built-in high speed mass storage interface of serial ATA, AC97 Audio with 5.1 channels surrounding sound.

#### **All in One multimedia solution**

Based on Intel 945GM and ICH7-M chipset, the board provides high performance onboard graphics, 18-bit Dual channel LVDS interface, DVI and HDTV and 5.1 channels AC97 Audio, to meet the every requirement of the multimedia application.

#### **Flexible Extension Interface**

The board also provides Compact Flash Type II socket and one mini-PCI socket.

## 1.2 <Product Specification>

### General Specification

Form Factor	3.5 inch miniboard
CPU	Intel® Core 2 Dual/Core Dual/Core Solo processor Package type: Micro-FCPGA478 Front side bus: 533/667MHz
Memory	1 x 200-pin DDR2 533/667MHz SO-DIMM SDRAM up to 2GB Unbuffered, none-ECC memory supported only
Chipset	Intel® 945GM and ICH7-M
BIOS	Phoenix-Award v6.00PG 4Mb PnP flash BIOS
Green Function	Power saving mode includes doze, standby and suspend modes. ACPI version 1.0 and APM version 1.2 compliant
Watchdog Timer	System reset programmable watchdog timer with 1 ~ 255 sec./min. of timeout value
Real Time Clock	Intel® ICH7-M built-in RTC with lithium battery
Enhanced IDE	UltraDMA33 IDE interface supports up to 2 ATAPI devices One 44-pin IDE port onboard One CompactFlash Type II socket on solder side
Serial ATA	Intel® ICH7-M integrates 2 Serial ATA interfaces (No RAID Function) Up to 150MB/s of transfer rate

### Multi-I/O Port

Chipset	Intel® ICH7-M with Winbond® W83627THG controller
Serial Port	One RS-232/422/485 serial port and one RS-232
USB Port	Two external & two internal Hi-Speed USB 2.0 ports with 480Mbps of transfer rate
IrDA Port	One IrDA compliant Infrared interface supports SIR
K/B & Mouse	PS/2 keyboard and mouse port
GPIO	One 12-pin Digital I/O connector with 8-bit programmable I/O interface
Smart Fan	One CPU fan connectors for fan speed controllable

### VGA Display Interface

Chipset	Intel® 945GM GMCH (Graphic Memory Controller Hub)
Frame Buffer	Up to 224MB shared with system memory
Display Type	CRT, LCD monitor with analog display, DVI, HDTV
Connector	External DB15 female connector on rear I/O panel Onboard 40-Pin LVDS connector Onboard 26-Pin DVI connector Onboard 10-Pin TV-out connector

### Ethernet Interface

Controller	1 x Intel 82573L Gigabit Ethernet controller
------------	--

Type	Triple speed 10/100/1000Base-T auto-switching Fast Ethernet Full duplex, IEEE802.3U compliant
Connector	One External RJ45 connector with LED on rear I/O panel

### Audio Interface

Chipset	REALTEK ALC655
Interface	5.1 channel surround audio with Line-in, Line-out and MIC-in
Connector	Onboard audio connector with pin header Onboard CD-IN connector

### Expansive Interface

Mini PCI	1 x Mini PCI socket
----------	---------------------

### Power and Environment

Power Requirement	DC 8~24V input with onboard 3-pin connector
Dimension	146.5 (L) x 101(H) mm
Temperature	Operating within 0 ~ 60°C Storage within -20 ~ 85°C

### Ordering Code

<b>LS-371</b>	Support Intel Core 2 Dual/Core Dual/ Core solo processor with onboard VGA, HDTV, DVI, LVDS, Audio, SATA, Giga LAN, USB2.0, CF, GPIO, Mini PCI, FDD
---------------	--

The specifications may be different as the actual production.

### 1.3 <Mechanical Drawing>

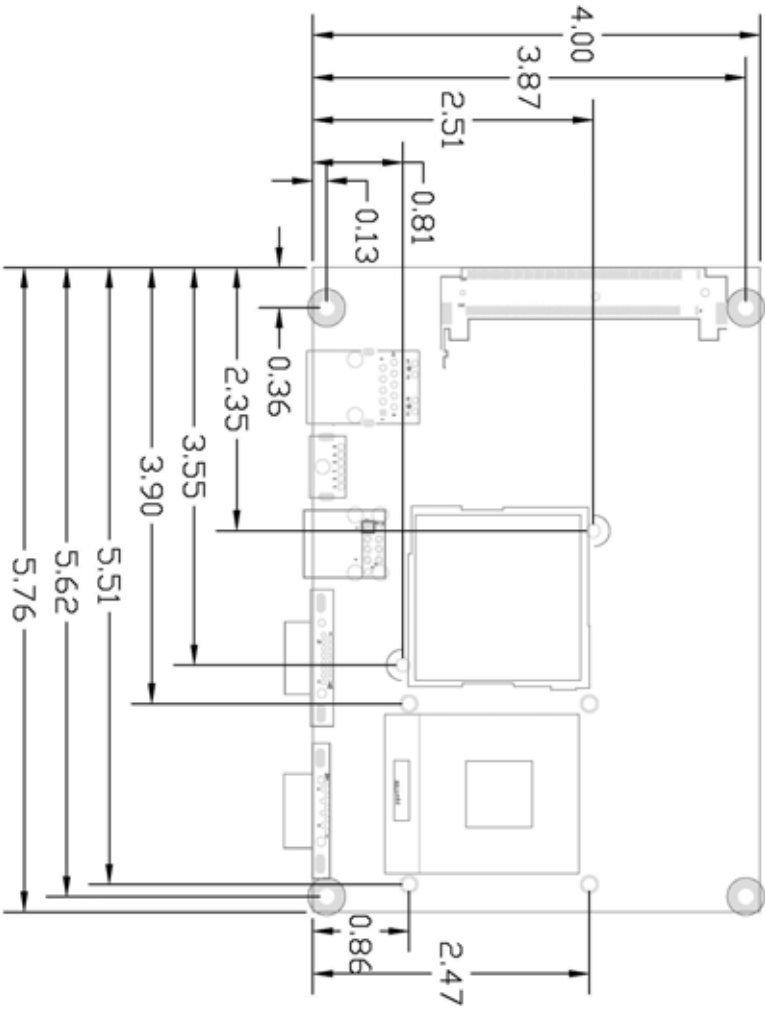

### 1.4 <Block Diagram>

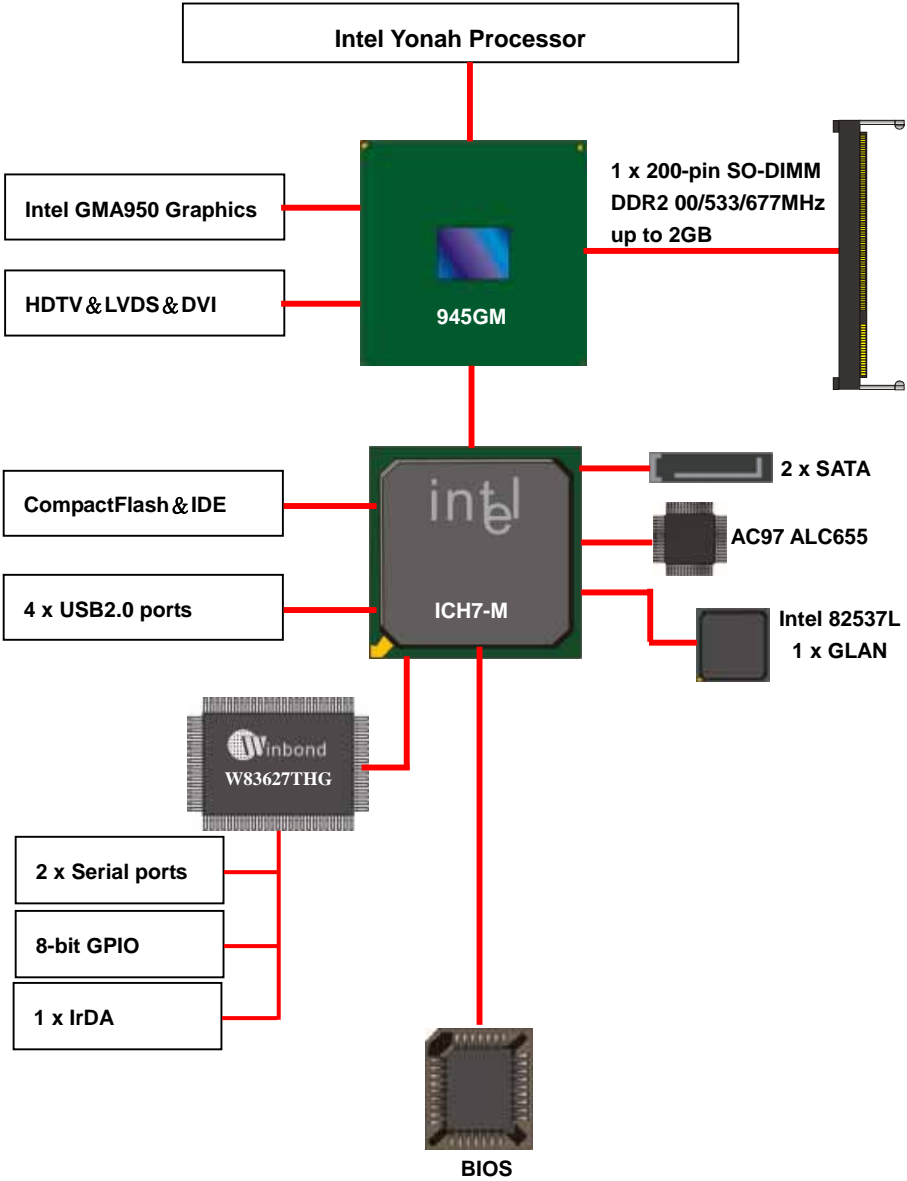

# Chapter 2 <Hardware Setup>

## 2.1 <Connector Location>

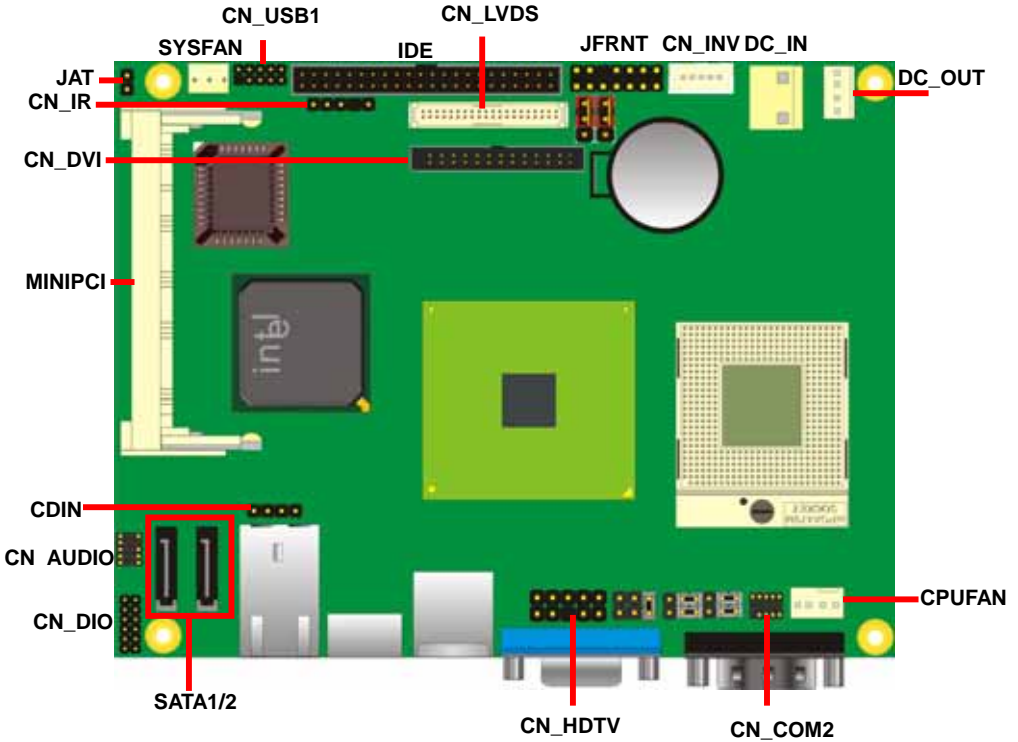

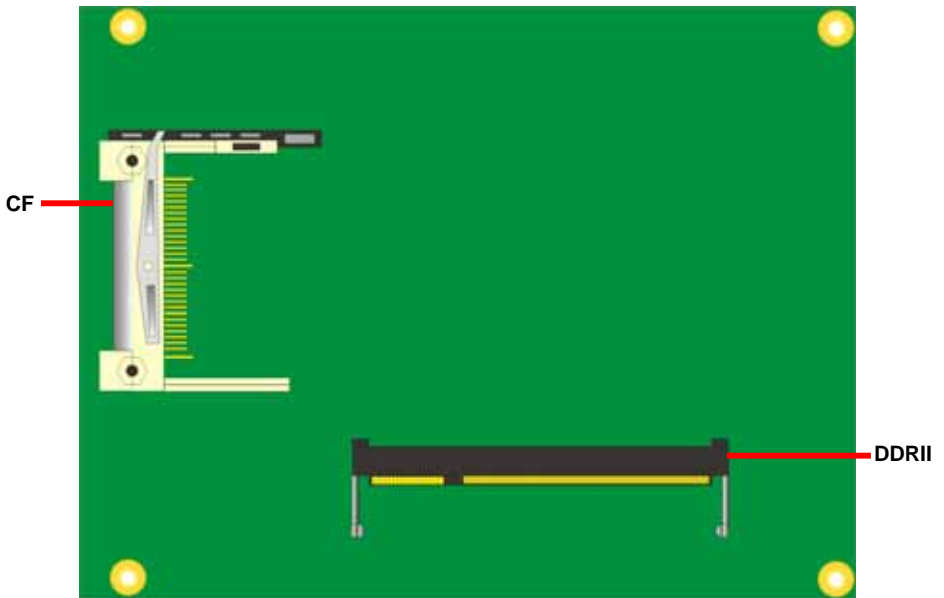

## 2.2 <Jumper Reference>

Jumper	Function
JRTC	CMOS Operating/Clear Setting
JVLCD	LCD Panel Voltage Setting
JAT	AT Mode
JCSEL1/2	COM2 RS232/422/485 mode setting

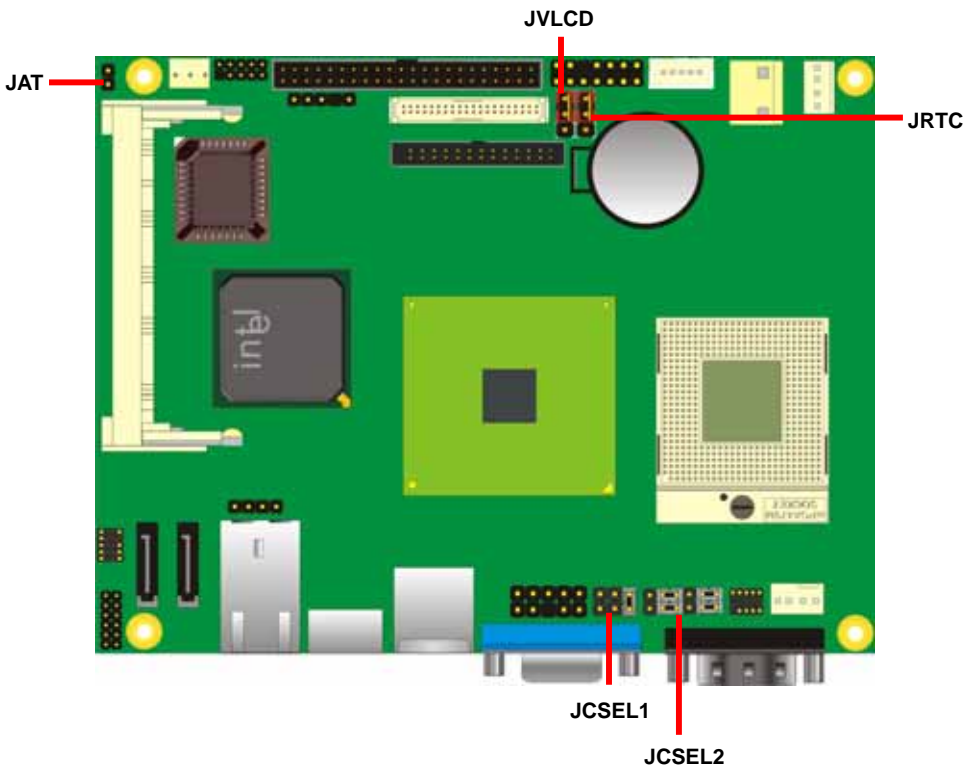

## 2.3 <Connector Reference>

### 2.3.1 <Internal Connector>

Connector	Function	Remark
DDR2	200 -pin DDR2 SO-DIMM SDRAM slot	Standard
IDE	44-pin primary IDE connector	Slim
SATA1/2	7-pin Serial ATA connector	Standard
CN_AUDIO	5 x 2-pin audio connector	Slim
CDIN	4-pin CD-ROM audio input connector	Standard
CN_DIO	6 x 2-pin digital I/O connector	Standard
CN_USB1	5 x 2-pin USB connector	Standard
CPUFAN	4-pin CPU cooler fan connector	Standard
SYSFAN	3-pin system cooler fan connector	Standard
CN_COM2	5 x 2-pin com connector	Slim
CN_IR	5-pin IrDA connector	Standard
CF	Compact Flash Type II socket	Standard
CN_LVDS	20 x 2-pin LVDS connector	Standard
CN_INV	5-pin LCD inverter connector	Standard
DC_OUT	4-pin power output connector	Standard
DC_IN	3-pin power input connector	Standard
MINIPCI	Mini-PCI socket	Standard
CN_DVI	13 x 2-pin DVI interface	Standard
CN_HDTV	5 x 2-pin HDTV interface	Standard
JFRNT	14-pin switch/indicator connector	Standard

### 2.3.2 <External Connector>

Connector	Function	Remark
CRT	DB15 VGA connector	Standard
USB	Dual USB 2.0 connector	Standard
COM1	DB9 Serial port connector	Standard
RJ45	One RJ45 LAN connector	Standard
PS2	PS/2 keyboard and mouse connector	Standard

## 2.4 <CPU and Memory Setup>

### 2.4.1 < CPU>

The board comes with the socket479 for Intel Core 2 Dual/Core Dual /Core solo processor , it supports new generation of Intel Core 2 Dual/Core Dual /Core solo processor with 533/667MHz of front side bus and 2MB L2 cache. Please follow the instruction to install the CPU properly.

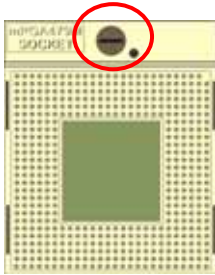

1. Use the flat-type screw drive to unlock the CPU socket



Unlock way

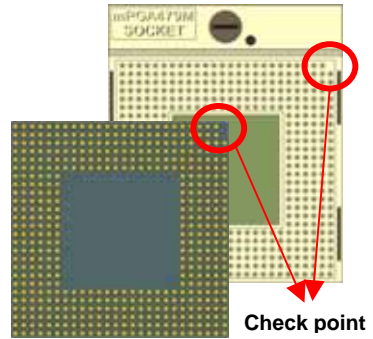

2. Follow the pin direction to install the processor on the socket



3. Lock the socket

### 2.4.2 <Memory>

The board provides one 200-pin DDR2 SO-DIMM to support DDR2 533/667 memory modules up to 2GB of capacity. Non-ECC, unbuffered memory is supported only. While applying two same modules, dual channel technology is enabled automatically for higher performance.

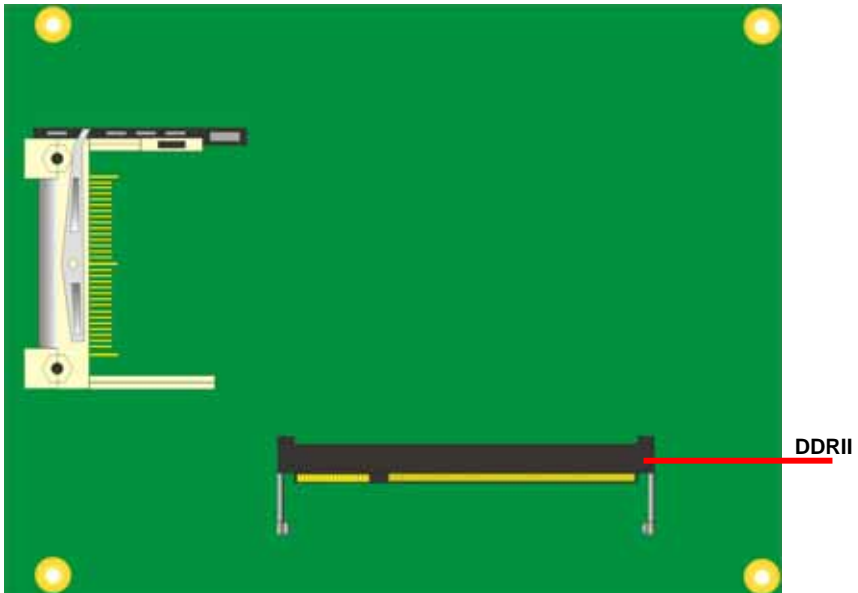

## 2.5 <CMOS & ATX Setup>

The board's data of CMOS can be setting in BIOS. If the board refuses to boot due to inappropriate CMOS settings, here is how to proceed to clear (reset) the CMOS to its default values.

Jumper: **JRTC**

Type: Onboard 3-pin jumper

JRTC	Mode
1-2	Clear CMOS
2-3	Normal Operation
Default setting	

Jumper: **JAT**

Type: onboard 2-pin header

JAT	Mode
Open	ATX Mode
Short	AT Mode
Default setting	

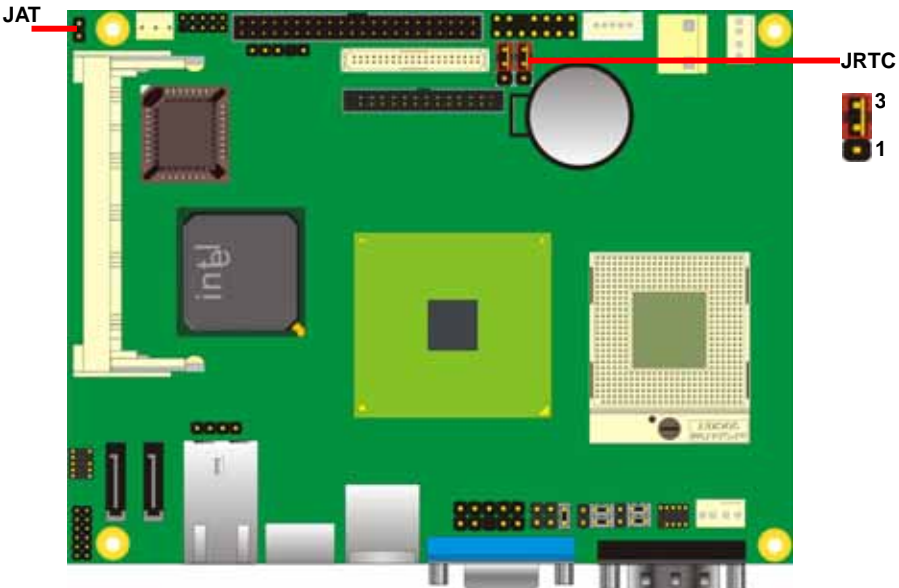

## 2.6 <Enhanced IDE & CF Interface>

The board has one Ultra DMA33 IDE interface to support up to 2 ATAPI devices, and one Compact Flash Type II socket on the solder side.

The board also provides a Compact Flash Type II socket with jumper (**JCFSEL**) selectable slave/Master mode on secondary IDE channel.

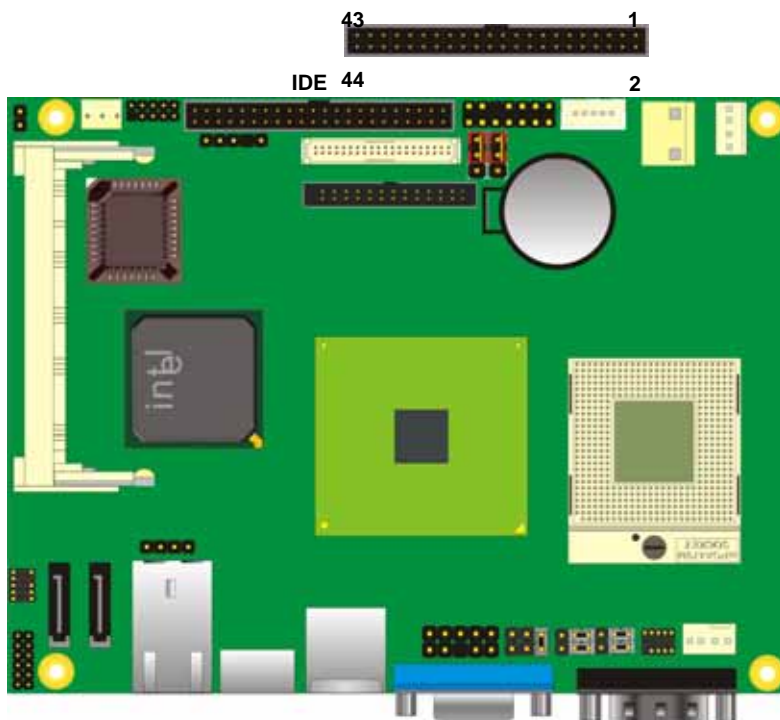

## 2.7 <Serial ATA Interface>

Based on Intel ICH7-M, the board provides two Serial ATA interfaces with up to 150MB/s of transfer rate.

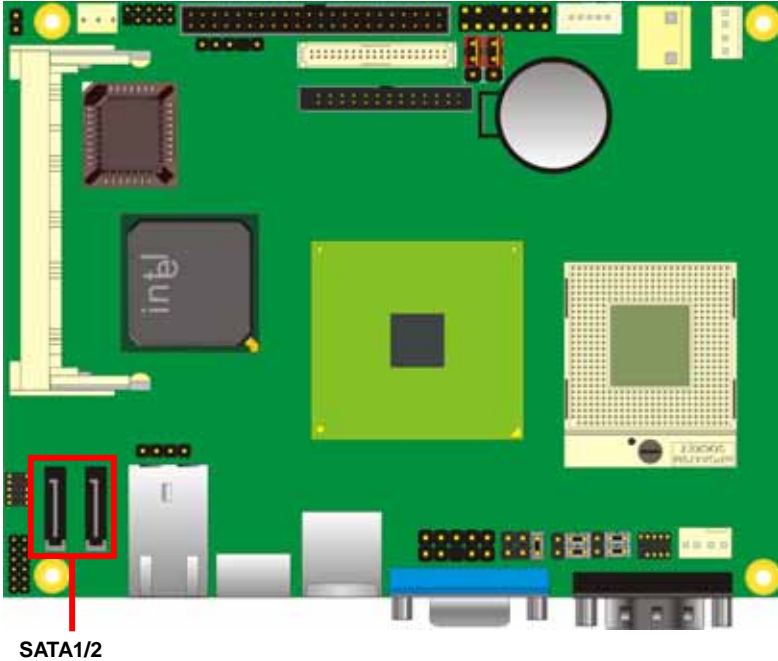

## 2.8 <LAN Interface>

The Intel 82573L supports triple speed of 10/100/1000Base-T, with IEEE802.3 compliance and Wake-On-LAN supported.



## 2.9 <Onboard Display Interface>

Based on Intel 945GM chipset with built-in GMA (Graphic Media Accelerator) 950 graphics, the board provides one DB15 connector on rear external I/O port, and one 40-pin LVDS interface with 5-pin LCD backlight inverter connector. The board provides dual display function with clone mode and extended desktop mode for CRT and LCD and DVI and TV-out.

### 2.9.1 <Analog VGA Interface>

Please connect your CRT or LCD monitor with DB15 male connector to the onboard DB15 female connector on rear I/O port.



### 2.9.2 <Digital Display>

The board provides one 40-pin LVDS connector for 18-bit dual channel panels, supports up to 1600 x 1200 (UXGA) of resolution, with one LCD backlight inverter connector and one jumper for panel voltage setting

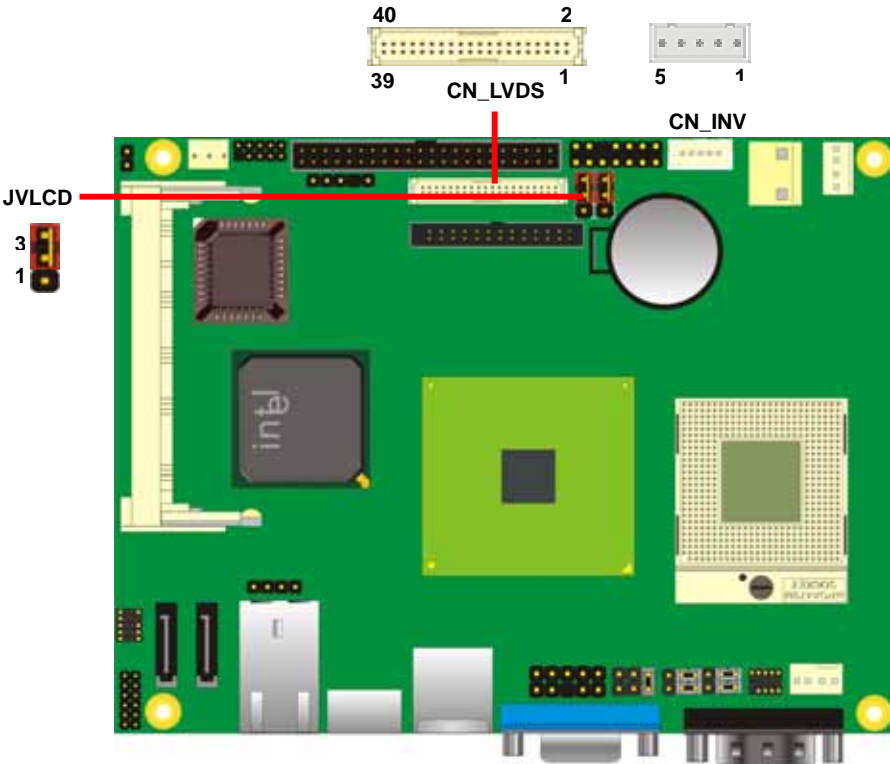

Connector: **CN\_INV**

Type: 5-pin LVDS Power Header

Connector model: **JST B5B-XH-A**

Pin	Description
1	+12V
2	GND
3	GND
4	GND
5	ENABKL

Connector: **JVLCD**

Type: 3-pin Power select Header

Pin	Description
1	VCC(5V)
2	LCDVCC
3	VCC3(3.3)

Connector: **CN\_LVDS**

Type: onboard 40-pin connector for LVDS connector

Connector model: **HIROSE DF13-40DP-1.25V**

Pin	Signal	Pin	Signal
2	LCDVCC	1	LCDVCC
4	GND	3	GND
6	ATX0-	5	BTX0-
8	ATX0+	7	BTX0+
10	GND	9	GND
12	ATX1-	11	BTX1-
14	ATX1+	13	BTX1+
16	GND	15	GND
18	ATX2-	17	BTX2-
20	ATX2+	19	BTX2+
22	GND	21	GND
24	ACLK-	23	BTX3-
26	ACLK+	25	BTX3+
28	GND	27	GND
30	ATX3-	29	BCLK-
32	ATX3+	31	BCLK+
34	GND	33	GND
36	N/C	35	N/C
38	N/C	37	N/C
40	N/C	39	N/C

To setup the LCD, you need the component below:

1. A panel with LVDS interfaces.
2. An inverter for panel's backlight power.
3. A LCD cable and an inverter cable.

For the cables, please follow the pin assignment of the connector to make a cable, because every panel has its own pin assignment, so we do not provide a standard cable; please find a local cable manufacture to make cables.

**LCD Installation Guide:**

1. Preparing the **LS-371, LCD panel** and the **backlight inverter**.

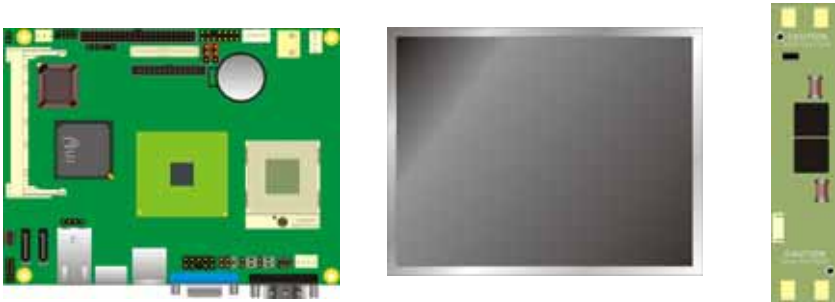

2. Please check the datasheet of the panel to see the voltage of the panel, and set the jumper **JVLCD** to +5V or +3.3V.
3. You would need a LVDS type cable.



4. To connect all of the devices well.

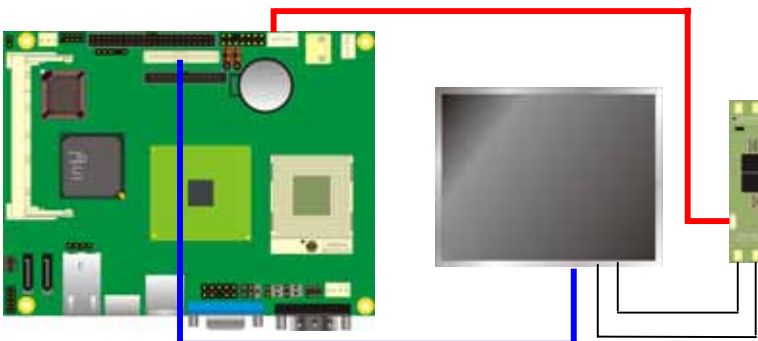

2.9.3 <DVI Interface >

The board also comes with a DVI interface with Chronitel CH7307C for digital video interface.

Connector: **CN\_DVI**

Connector type: 26-pin header connector (pitch = 2.54mm)

Pin Number	Assignment	Pin Number	Assignment
1	TX1+	2	TX1-
3	Ground	4	Ground
5	TXC+	6	TXC-
7	Ground	8	PVDD
9	N/C	10	N/C
11	TX2+	12	TX2-
13	Ground	14	Ground
15	TX0+	16	TX0-
17	N/C	18	HPDET
19	DDCDATA	20	DDCCLK
21	GND	22	N/C
23	N/C	24	N/C
25	N/C	26	N/C

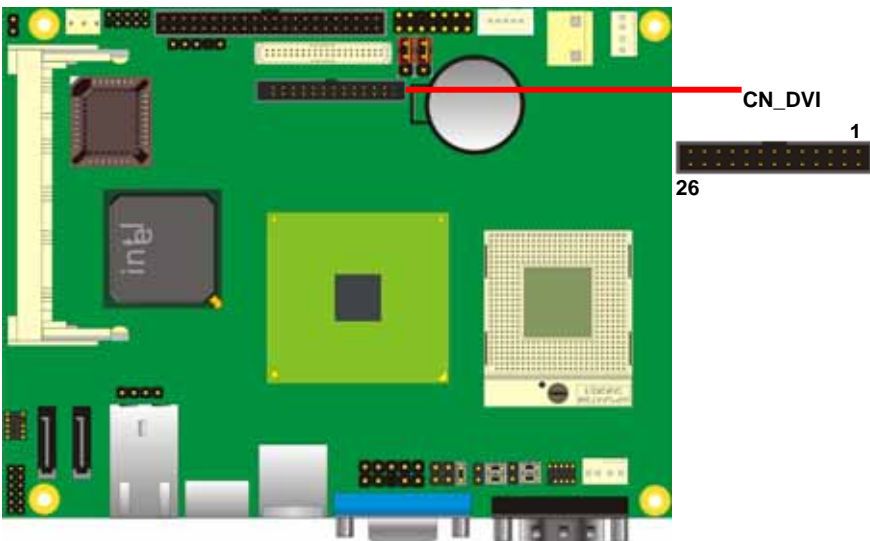

### 2.9.4<TV-out Interface>

The board provides an HDTV interface with Intel 945GM, supports PAL and NTSC of TV system, and display (clone or extended desktop) function with CRT,LVDS,DVI.

Connector: **CN\_HDTV**

Connector type: 10-pin header HDTV connector (pitch = 2.54mm)

Pin Number	Assignment	Pin Number	Assignment
1	GND	2	DACB1
3	DACB2	4	N/C
5	GND	6	GND
7	DACB3	8	N/C
9	N/C	10	+5V

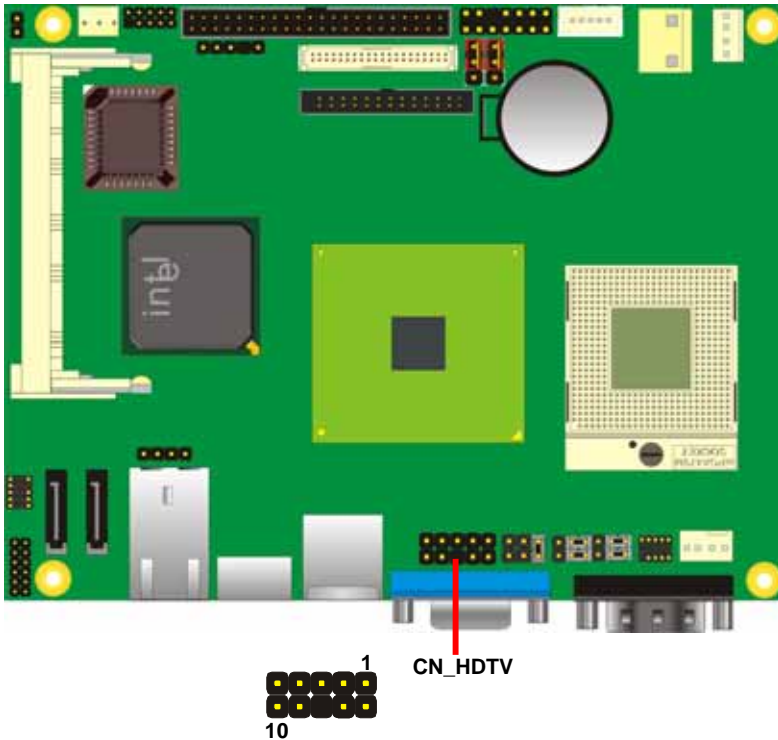

To connect the TV set, please follow the diagram below to setup your system:

YPrPb Component Cable  
(For HDTV)

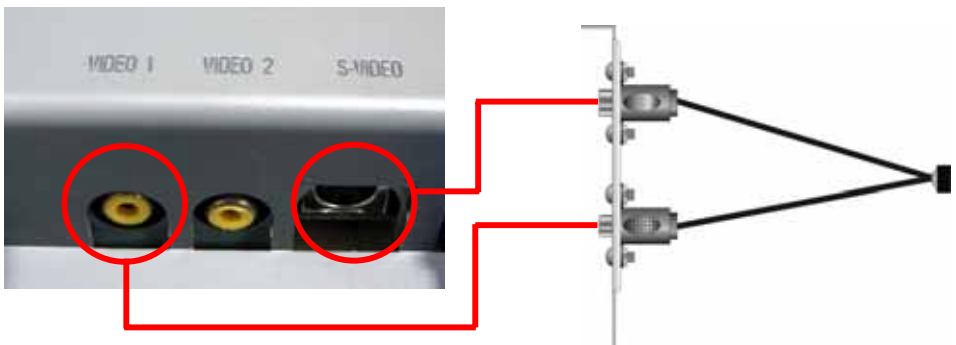
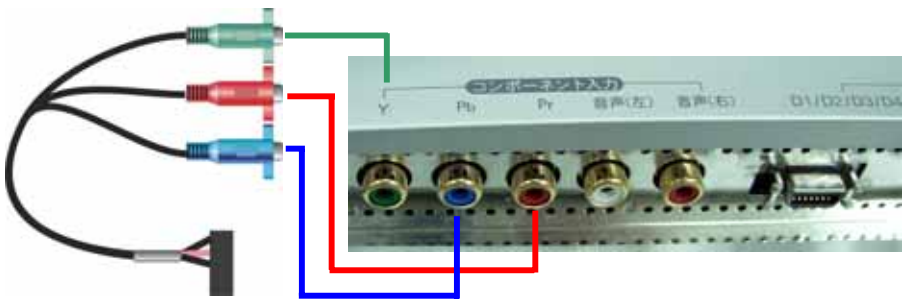
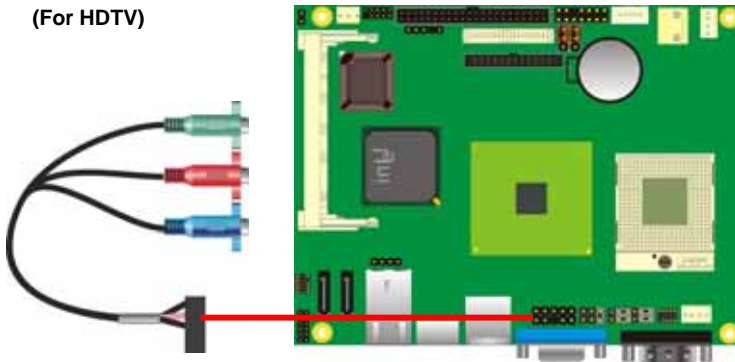

After setup the devices well, you need to select the LCD panel type in the BIOS.



The panel type mapping is list below:

BIOS panel type selection form			
18 bits Single channel		24 bits Dual channel	
NO.	Output format	NO.	Output format
1	640 x 480	9	1024 x 768
2	800 x 600	10	1280 x 768
3	1024 x 768	11	1280 x 1024
24 bits Single channel		12	1366 x 768
4	1280 x 768	13	1400 x 1050 @ 108Mhz
5	1280 x 1024	15	1600 x 1200
6	1366 x 768		
7	1280 x 800		
8	1600 x 1200		
14	1024 x 768		

## 2.10 <Onboard Audio Interface>

The board provides the onboard AC97 5.1-channel audio interface with Realtek ALC655

### Connector: CN\_AUDIO

Type: 10-pin (2 x 5) 1.27mm x 2.54mm-pitch header

Pin	Description	Pin	Description
1	LIN_L	2	Ground
3	LIN_R	4	MIC 2
5	MIC 2	6	Ground
7	N/C	8	FRONTL
9	FRONTR	10	Ground

### Connector: CDIN

Type: 4-pin header (pitch = 2.54mm)

Pin	Description
1	CD – Left
2	Ground
3	Ground
4	CD – Right

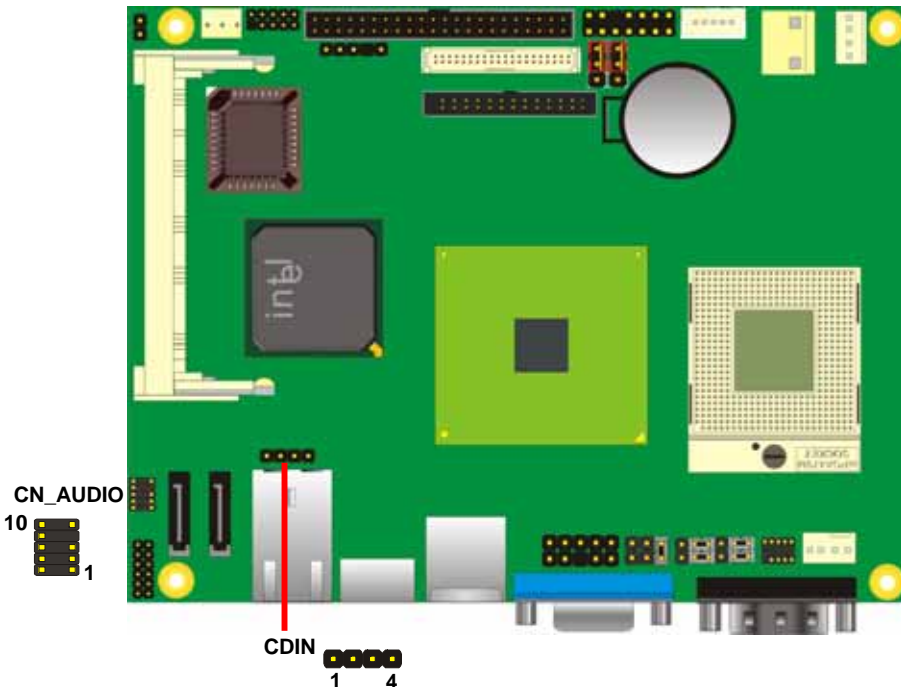

## 2.11 <USB2.0 Interface>

Based on Intel ICH7-M , the board provides 4 USB2.0 ports. The USB2.0 interface provides up to 480Mbps of transferring rate.

Interface	USB2.0
Controller	ICH7-M
Transfer Rate	Up to 480Mb/s
Output Voltage	500mA

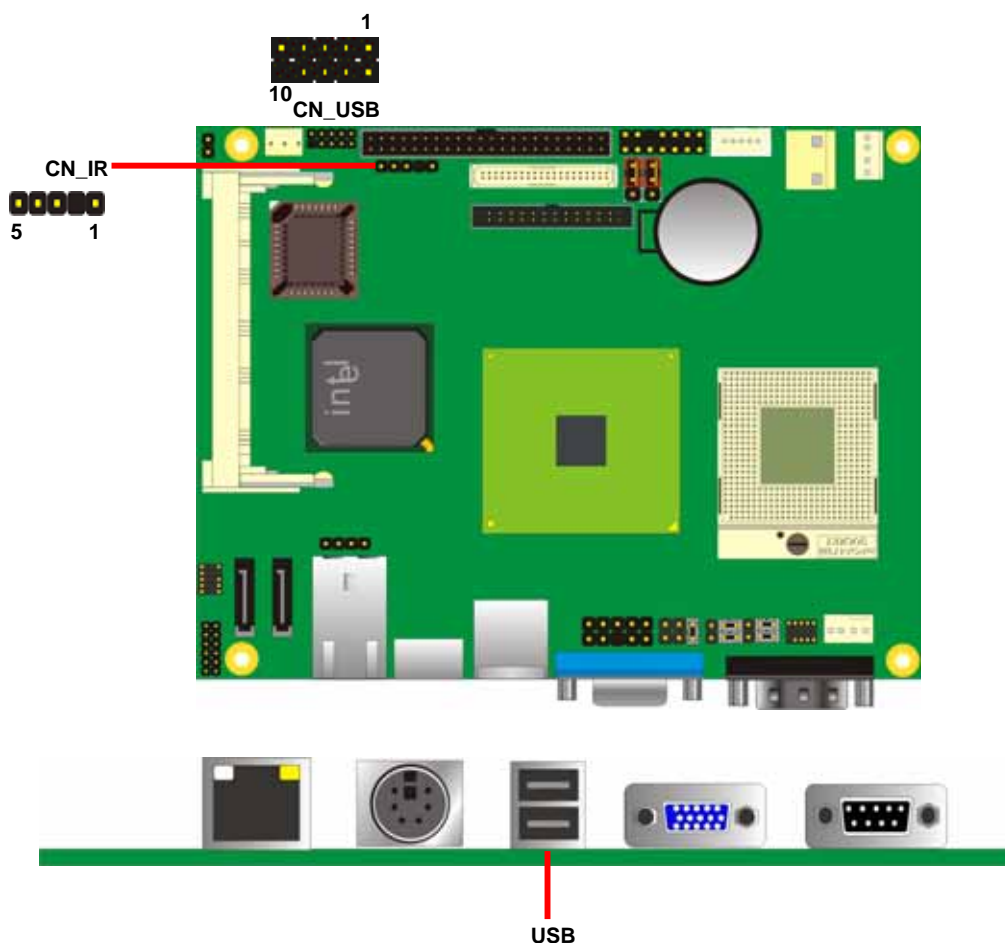

Connector: **CN\_IR**

Type: 5-pin header for SIR Port

Pin	Description
1	Vcc
2	N/C
3	IRRX
4	Ground
5	IRTX

Connector: **CN\_USB**

Type: 10-pin (5 x 2) header for USB Port

Pin	Description	Pin	Description
1	VCC	2	VCC
3	Data0-	4	Data1-
5	Data0+	6	Data1+
7	Ground	8	Ground
9	Ground	10	N/C

PS: The USB2.0 will be only active when you connecting with the USB2.0 devices, if you insert an USB1.1 device, the port will be changed to USB1.1 protocol automatically. The transferring rate of USB2.0 as 480Mbps is depending on device capacity, exact transferring rate may not be up to 480Mbps.

## 2.12 <GPIO Interface>

The board provides a programmable 8-bit digital I/O interface; you can use this general purpose I/O port for system control like POS or KIOSK.

Connector: **CN\_DIO**

Type: onboard 2 x 6-pin header, pitch=2.0mm

Pin	Description	Pin	Description
1	Ground	2	Ground
3	GP0	4	GP4
5	GP1	6	GP5
7	GP2	8	GP6
9	GP3	10	GP7
11	VCC	12	+12V

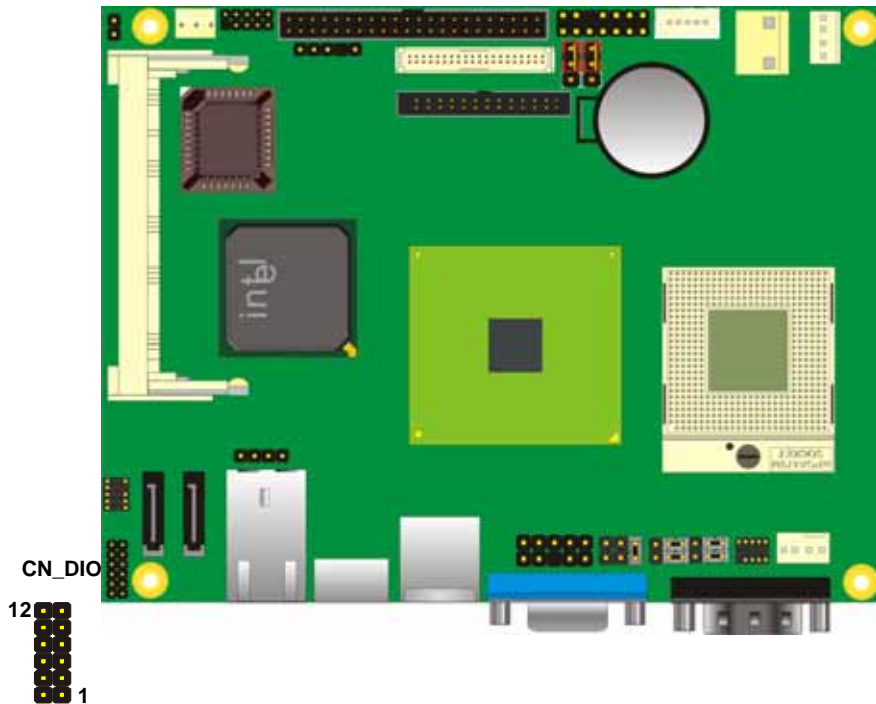

## 2.13 <Serial Port Jumper Setting >

The board provides three RS232 serial ports, with jumper selectable RS422/485 for COM2.

Connector: **CN\_COM2**

Type: 10-pin (5 x 2) 1.27mm x 2.54mm-pitch header for COM2



Pin	Description	Pin	Description
1	DCD/422RX-/485-	2	RXD/422RX+/485+
3	TXD/422TX+	4	DTR/422TX-
5	GND	6	DSR
7	RTS	8	CTS
9	RI	10	N/C

	JCSEL1	JCSEL2
<b>RS-232</b>		
<b>RS-485</b>		
<b>RS-422</b>		

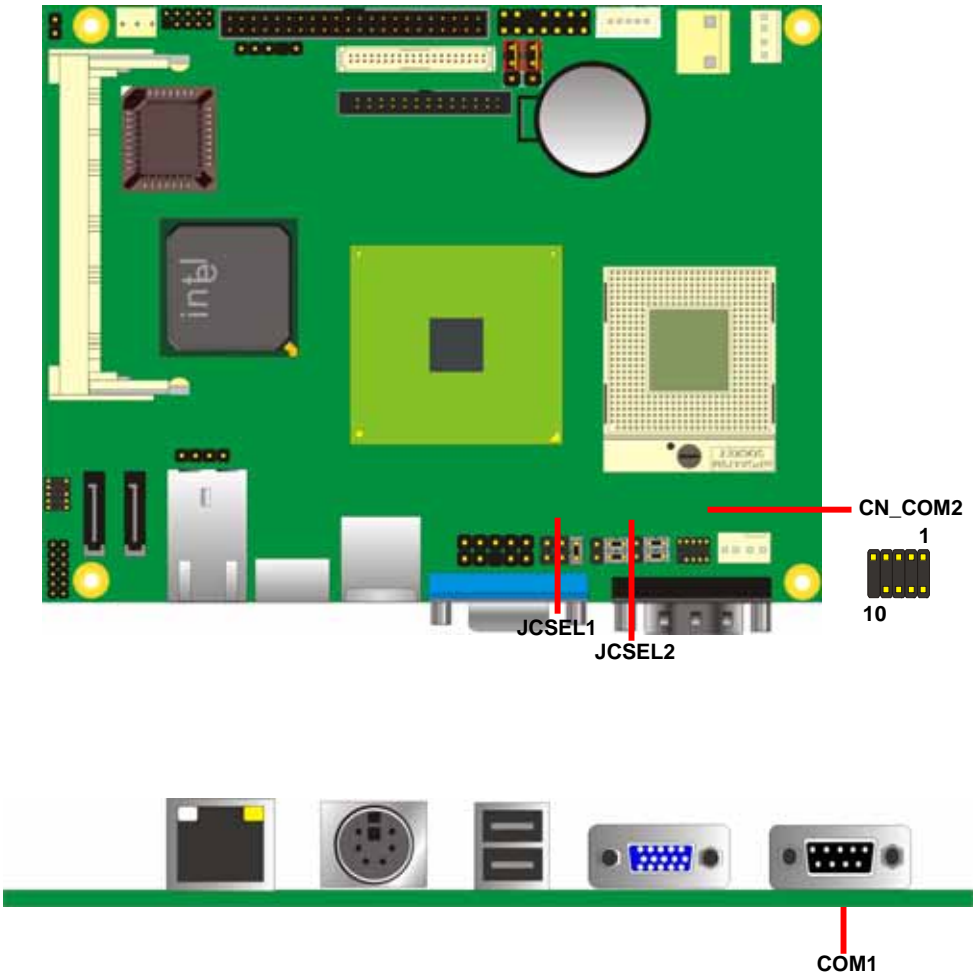

## 2.14 <Power and Fan Connector>

The board requires DC input with 3-pin header, the input voltage range is from 8V to 24V, for the input current, please take a reference of the power consumption report on appendix.

### 2.15.1 <Power Input>

Connector: DC\_IN

Pin	Description	Pin	Description	Pin	Description
1	DC_IN	2	NC	3	Ground

**Remark:** DC input voltage range 8~24V

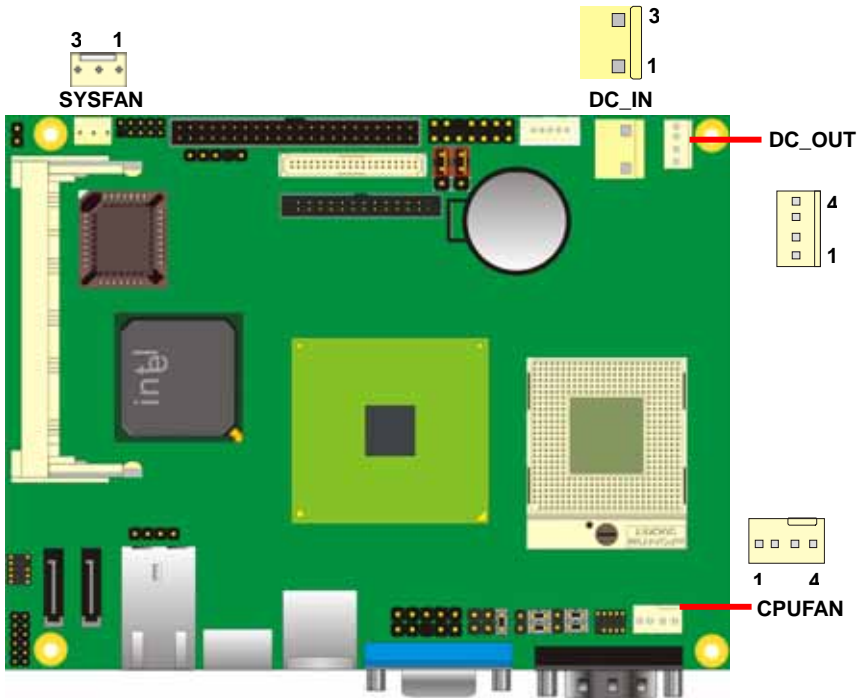

### 2.14.2 <Power Output>

Connector: **DC\_OUT**

Type: 4-pin connector for +5V/+12V **output**

Pin	Description	Pin	Description	Pin	Description	Pin	Description
1	+12V	2	Ground	3	Ground	4	+5V

### 2.14.3 <Fan Connector>

Connector: **SYSFAN**

Type: 3-pin fan wafer connector

Pin	Description	Pin	Description	Pin	Description
1	Ground	2	+12V	3	Fan Speed detect

Connector: **CPUFAN**

Type: 4-pin P-type connector for +5V/+12V output

Pin	Description	Pin	Description	Pin	Description	Pin	Description
1	+12V	2	Ground	3	Fan Speed detect	4	Fan Control

## 2.15 <Indicator and Switch>

The **JFRNT** provides front control panel of the board, such as power button, reset and beeper, etc. Please check well before you connecting the cables on the chassis.

Connector: **JFRNT**

Type: onboard 14-pin (2 x 7) 2.54-pitch header

Function	Signal	PIN		Signal	Function
IDE LED	HDLED+	1	2	PWRLED+	Power LED
	HDLED-	3	4	N/C	
Reset	Reset+	5	6	PWRLED-	Speaker
	Reset-	7	8	SPK+	
N/C		9	10	N/C	
Power Button	PWRBT+	11	12	N/C	
	PWRBT-	13	14	SPK-	



JFRNT

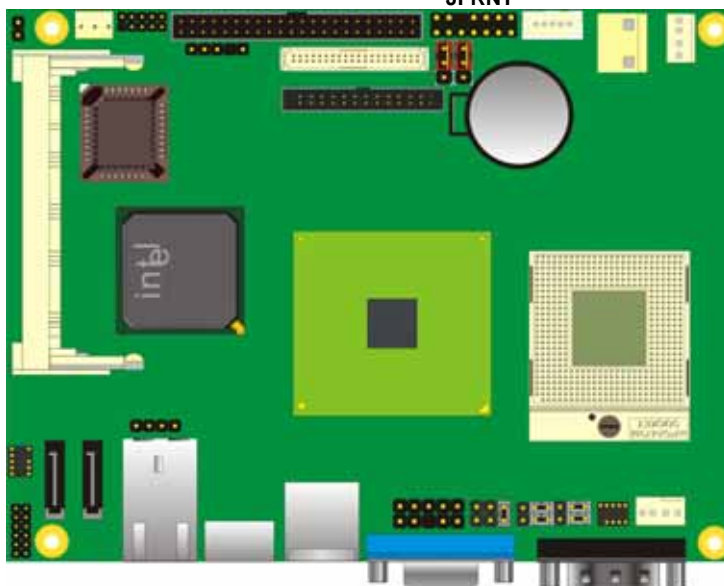

**(This Page is Left For Blank)**

## Chapter 3 <System Configuration>

### 3.1 <Video Memory Setup>

Based on Intel® 945GM chipset with GMA (Graphic Media Accelerator) 950, the board supports Intel® DVMT (Dynamic Video Memory Technology) 3.0, which would allow the video memory to be allocated up to 224MB.

To support DVMT, you need to install the Intel GMA 950 Driver with supported OS.

#### BIOS Setup:



#### On-Chip Frame Buffer Size:

This item can let you select video memory which been allocated for legacy VGA and SVGA graphics support and compatibility. The available option is **1MB** and **8MB**.

#### Fixed + DVMT Memory Size:

You can select the fixed amount and the DVMT amount at the same time for a guaranteed video memory and additional dynamic video memory, please check the table below for available setting.

Notice:

1. The On-Chip Frame Buffer Size would be included in the Fixed Memory.

Please select the memory size according to this table.

SBIOS Options				System Memory
Pre-Allocated Memory	Fixed	DVMT	Fixed+DVMT	
1MB(1)	32MB	32MB	NA	128MB
8MB	32MB	32MB	NA	128MB
1MB(1)	64MB	64MB	NA	256MB
	128MB	128MB	64MB+64MB	256MB
8MB	64MB	64MB	NA	256MB
	128MB	128MB	64MB+64MB	256MB
1MB(1)	64MB	64MB	NA	512MB
	128MB	128MB	64MB+64MB	512MB
	NA	"Maximum DVMT"	NA	512MB
8MB	64MB	64MB	NA	512MB
	128MB	128MB	64MB+64MB	512MB
	NA	"Maximum DVMT"	NA	512MB

The panel type mapping is list below:

BIOS panel type selection form				
18 bits Single channel			24 bits Dual channel	
NO.	Output format		NO.	Output format
1	640 x 480		9	1024 x 768
2	800 x 600		10	1280 x 768
3	1024 x 768		11	1280 x 1024
24 bits Single channel			12	1366 x 768
4	1280 x 768		13	1400 x 1050 @ 108Mhz
5	1280 x 1024		15	1600 x 1200
6	1366 x 768			
7	1280 x 800			
8	1600 x 1200			
14	1024 x 768			

### **3.2 <Audio Configuration>**

The board provides 5.1 channel audio interface with driver installed, please install the Realtek ALC655 audio driver in the CD before getting start to enjoy the 5.1 channel sound system.

(This Page is Left for Blank)

## Chapter 4 <BIOS Setup>

The motherboard uses the Award BIOS for the system configuration. The Award BIOS in the single board computer is a customized version of the industrial standard BIOS for IBM PC AT-compatible computers. It supports Intel x86 and compatible CPU architecture based processors and computers. The BIOS provides critical low-level support for the system central processing, memory and I/O sub-systems.

The BIOS setup program of the single board computer let the customers modify the basic configuration setting. The settings are stored in a dedicated battery-backed memory, NVRAM, retains the information when the power is turned off. If the battery runs out of the power, then the settings of BIOS will come back to the default setting.

The BIOS section of the manual is subject to change without notice and is provided here for reference purpose only. The settings and configurations of the BIOS are current at the time of print, and therefore they may not be exactly the same as that displayed on your screen.

To activate CMOS Setup program, press <DEL> key immediately after you turn on the system. The following message "Press DEL to enter SETUP" should appear in the lower left hand corner of your screen. When you enter the CMOS Setup Utility, the Main Menu will be displayed as **Figure 4-1**. You can use arrow keys to select your function, press <Enter> key to accept the selection and enter the sub-menu.

**Figure 4-1** CMOS Setup Utility Main Screen

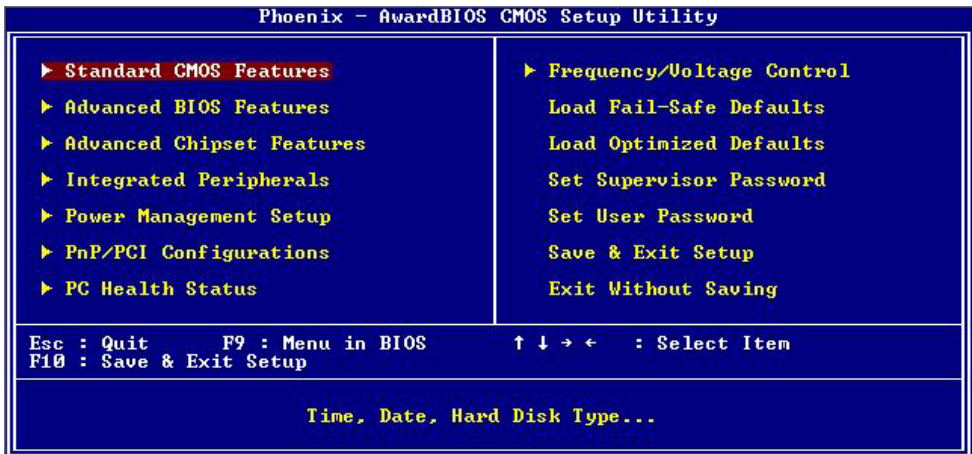

(This Page is Left for Blank)

## Appendix A <I/O Port Pin Assignment>

### A.1 <IDE Port>

Connector: IDE

Type: 44-pin (22 x 2) box header



Pin	Description	Pin	Description
1	Reset	2	Ground
3	D7	4	D8
5	D6	6	D9
7	D5	8	D10
9	D4	10	D11
11	D3	12	D12
13	D2	14	D13
15	D1	16	D14
17	D0	18	D15
19	Ground	20	N/C
21	REQ	22	Ground
23	IOW-/STOP	24	Ground
25	IOR-/HDMARDY	26	Ground
27	IRDY/DDMARDY	28	Ground
29	DACK-	30	Ground
31	IRQ	32	N/C
33	A1	34	SD
35	A0	36	A2
37	CS1	38	CS3
39	ASP1	40	Ground
41	Vcc	42	Vcc
43	Ground	44	Ground

## A.2 <IrDA Port>

Connector: CN\_IR

Type: 5-pin header for SIR Port



Pin	Description
1	Vcc
2	N/C
3	IRRX
4	Ground
5	IRTX

## A.3 < CRT Port >

Connector: CRT

Type: 15-pin D-sub female connector on panel

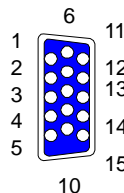

Pin	Description	Pin	Description	Pin	Description
1	RED	6	Ground	11	N/C
2	GREEN	7	Ground	12	5VCCA
3	BLUE	8	Ground	13	HSYNC
4	N/C	9	LVGA5V	14	VSYNC
5	Ground	10	Ground	15	5VCLK

## A.4 <Serial ATA Port>

Connector: SATA1/2

Type: 7-pin wafer connector

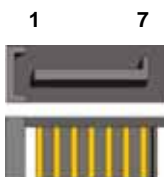

1	2	3	4	5	6	7
GND	RSATA_TXP1	RSATA_TXN1	GND	RSATA_RXN1	RSATA_RXP1	GND

## A.5 <Serial Port>

Connector: **COM1**

Type: 9-pin D-sub male connector on rear panel

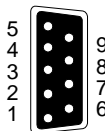

Pin	Description	Pin	Description
1	DCD	6	DSR
2	SIN	7	RTS
3	SO	8	CTS
4	DTR	9	RI
5	Ground		

## A.6 <LAN Port>

Connector: **RJ45**

Type: RJ45 connector with LED on rear panel

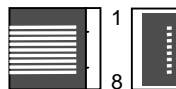

Pin	1	2	3	4	5	6	7	8
Description	TX+	TX-	RX+	N/C	N/C	RX-	N/C	N/C

## Appendix B <Flash BIOS>

### B.1 BIOS Auto Flash Tool

The board is based on Award BIOS and can be updated easily by the BIOS auto flash tool. You can download the tool online at the address below:

<http://www.award.com>

File name of the tool is "awdf flash.exe", it's the utility that can write the data into the BIOS flash chip and update the BIOS.

### B.2 Flash Method

1. Please make a bootable floppy disk.
2. Get the last .bin files you want to update and copy it into the disk.
3. Copy awardflash.exe to the disk.
4. Power on the system and flash the BIOS. (Example: C:/ awardflash XXX.bin)
5. Re-start the system.

## Appendix C <System Resources>

### C1.<I/O Port Address Map>

[00000000 - 0000000F]	Direct memory access controller
[00000010 - 0000001F]	Motherboard resources
[00000020 - 00000021]	Programmable interrupt controller
[00000022 - 0000003F]	Motherboard resources
[00000040 - 00000043]	System timer
[00000044 - 0000005F]	Motherboard resources
[00000060 - 00000060]	Standard 101/102-Key or Microsoft Natural PS/2 Keyboard
[00000061 - 00000061]	System speaker
[00000062 - 00000063]	Motherboard resources
[00000064 - 00000064]	Standard 101/102-Key or Microsoft Natural PS/2 Keyboard
[00000065 - 0000006F]	Motherboard resources
[00000070 - 00000073]	System CMOS/real time clock
[00000074 - 0000007F]	Motherboard resources
[00000080 - 00000090]	Direct memory access controller
[00000091 - 00000093]	Motherboard resources
[00000094 - 0000009F]	Direct memory access controller
[000000A0 - 000000A1]	Programmable interrupt controller
[000000A2 - 000000BF]	Motherboard resources
[000000C0 - 000000DF]	Direct memory access controller
[000000E0 - 000000EF]	Motherboard resources
[000000F0 - 000000FF]	Numeric data processor
[00000170 - 00000177]	Secondary IDE Channel
[000001F0 - 000001F7]	Primary IDE Channel
[00000200 - 00000200]	Standard Game Port
[00000201 - 00000207]	Standard Game Port
[00000274 - 00000277]	ISAPNP Read Data Port
[00000279 - 00000279]	ISAPNP Read Data Port
[000002F8 - 000002FF]	Communications Port (COM2)
[00000376 - 00000376]	Secondary IDE Channel
[000003B0 - 000003BB]	Mobile Intel(R) 945GM Express Chipset Family
[000003C0 - 000003DF]	Mobile Intel(R) 945GM Express Chipset Family
[000003F0 - 000003F5]	Standard floppy disk controller
[000003F6 - 000003F6]	Primary IDE Channel
[000003F7 - 000003F7]	Standard floppy disk controller
[000003F8 - 000003FF]	Communications Port (COM1)
[00000400 - 000004BF]	Motherboard resources
[000004D0 - 000004D1]	Motherboard resources

[00000500 - 0000051F] Intel(R) 82801G (ICH7 Family) SMBus Controller - 27DA

[00000800 - 0000087F] Motherboard resources

[00000880 - 0000088F] Motherboard resources

[00000A79 - 00000A79] ISAPNP Read Data Port

## C2.<Memory Address Map>

[00000000 - 0009FFFF] System board

[000A0000 - 000BFFFF] PCI bus

[000A0000 - 000BFFFF] Mobile Intel(R) 945GM Express Chipset Family

[000C0000 - 000DFFFF] PCI bus

[000E0000 - 000EFFFF] System board

[000F0000 - 000F7FFF] System board

[000F8000 - 000FBFFF] System board

[000FC000 - 000FFFFF] System board

[00100000 - 3F6DFFFF] System board

[00636500 - 00D1CCFF] System board

[3F6E0000 - 3F6FFFFF] System board

[3F700000 - FEBFFFFF] PCI bus

[D0000000 - DFFFFFFF] Mobile Intel(R) 945GM Express Chipset Family

[E0000000 - EFFFFFFF] Motherboard resources

[FDB00000 - FDBFFFFF] Intel(R) 82801G (ICH7 Family) PCI Express Root Port - 27D0

[FDBE0000 - FDBFFFFF] Intel(R) PRO/1000 PL Network Connection

[FDC00000 - FDCFFFFF] Intel(R) 82801G (ICH7 Family) PCI Express Root Port - 27D0

[FDE80000 - FDEFFFFF] Mobile Intel(R) 945GM Express Chipset Family

[FDF00000 - FDF7FFFF] Mobile Intel(R) 945GM Express Chipset Family

[FDF80000 - FDFBFFFF] Mobile Intel(R) 945GM Express Chipset Family

[FDFFC000 - FDFFC3FF] Intel(R) 82801GBM/GHM (ICH7-M Family) Serial ATA Storage Controller - 27C4

[FDFFD000 - FDFFD0FF] Realtek AC'97 Audio

[FDFFE000 - FDFFE1FF] Realtek AC'97 Audio

[FDFFF000 - FDFFF3FF] Intel(R) 82801G (ICH7 Family) USB2 Enhanced Host Controller - 27CC

[FEC00000 - FEC00FFF] System board

[FED13000 - FED1DFFF] System board

[FED20000 - FED8FFFF] System board

[FEE00000 - FEE00FFF] System board

[FFB00000 - FFB7FFFF] System board

[FFB80000 - FFBFFFFF] Intel(r) 82802 Firmware Hub Device

[FFF00000 - FFFFFFFF] System board

### C3.<System IRQ Resources>

(ISA) 0	System timer
(ISA) 1	Standard 101/102-Key or Microsoft Natural PS/2 Keyboard
(ISA) 3	Communications Port (COM2)
(ISA) 4	Communications Port (COM1)
(ISA) 6	Standard floppy disk controller
(ISA) 8	System CMOS/real time clock
(ISA) 9	Microsoft ACPI-Compliant System
(ISA) 12	PS/2 Compatible Mouse
(ISA) 13	Numeric data processor
(ISA) 14	Primary IDE Channel
(ISA) 15	Secondary IDE Channel
(PCI) 11	Intel(R) 82801G (ICH7 Family) SMBus Controller - 27DA
(PCI) 16	Intel(R) 82801G (ICH7 Family) PCI Express Root Port - 27D0
(PCI) 16	Intel(R) 82801G (ICH7 Family) USB Universal Host Controller - 27CB
(PCI) 16	Intel(R) PRO/1000 PL Network Connection
(PCI) 16	Mobile Intel(R) 945GM Express Chipset Family
(PCI) 17	Realtek AC'97 Audio
(PCI) 18	Intel(R) 82801G (ICH7 Family) USB Universal Host Controller - 27CA
(PCI) 19	Intel(R) 82801G (ICH7 Family) USB Universal Host Controller - 27C9
(PCI) 23	Intel(R) 82801G (ICH7 Family) USB Universal Host Controller - 27C8
(PCI) 23	Intel(R) 82801G (ICH7 Family) USB2 Enhanced Host Controller - 27CC

## Appendix D <Watch Dog timer Setting >

The watchdog timer makes the system auto-reset while it stops to work for a period. The integrated watchdog timer can be setup as system reset mode by program.

### Timeout Value Range

- 1 to 255
- Second or Minute

### Program Sample

Watchdog timer setup as system reset with 5 second of timeout

---

```

2E, 87
2E, 87
2E, 07
2F, 08      Logical Device 8
2E, 30      Activate
2F, 01
2E, F5      Set as Second*
2F, 00
2E, F6      Set as 5
2F, 05

```

---

\* Minute: bit 3 = 0; Second: bit 3 = 1

You can select Timer setting in the BIOS, after setting the time options, the system will reset according to the period of your selection.

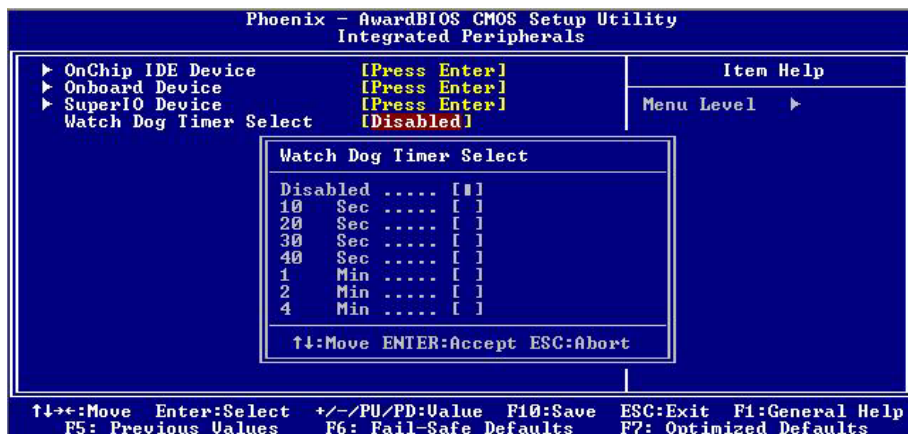

**(This Page is Left for Blank)**

Any advice or comment about our products and service, or anything we can help you please don't hesitate to contact with us. We will do our best to support you for your products, projects and business.

---

Annso Technology Co.,LTD

Address	The south faces industry area of Xia Gang Fu Hai road, Chang'an Town,Dongguan City, Guangdong, China
TEL	<a href="tel:+86-769-81666306">+86-769-81666306</a>
FAX	<a href="tel:+86-769-81666306">+86-769-81666306</a>
Website	<a href="http://www.annso.com">http://www.annso.com</a>
E-Mail	<a href="mailto:sales@annso.com.cn">sales@annso.com.cn</a>

---